

ECOLINE 270



RUTHMANNECOLINE 270

WELCOME TO THE NEXT LEVEL







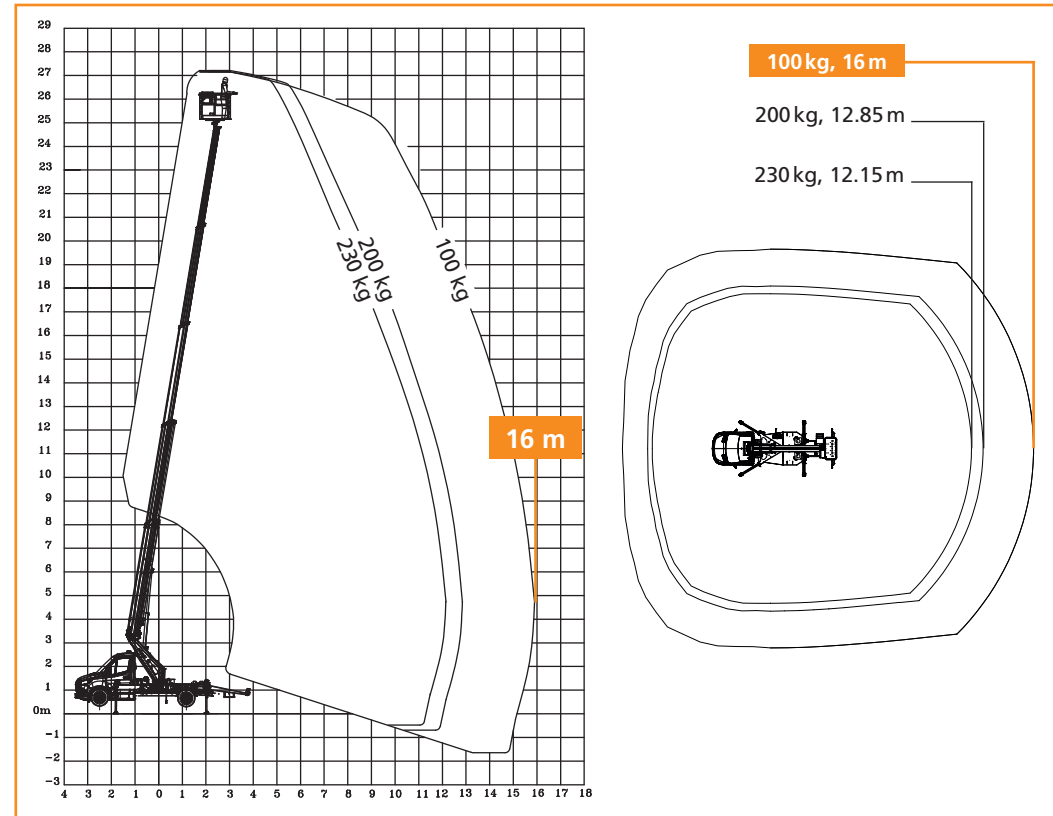



ECOLINE 270 – The leap to the top

- +** 27 meters working height - top in the „low budget segment“
- +** Up to 16 meters outreach
- +** Stable fine-grained steel construction with high durability and reliability
- +** Large permissible inclination of the base frame up to 5° (4° more than the competition) thereby problem-free and safe positioning on slopes.



i Mature, reliable technology

High performance data promise high rental income with simultaneously low purchasing and operating costs. With a working height of 27 meters, the ECOLINE is suitable for nearly all utilisations and is very compact with an overall length of only 7.53 meters.

	27.00 m		±90°		3.07 m
	16 m		1.30 m x 0.70 m		7.53 m
	360°		230 kg	 xx,xxx t	3,500 kg

ECOLINE 270 – the next level

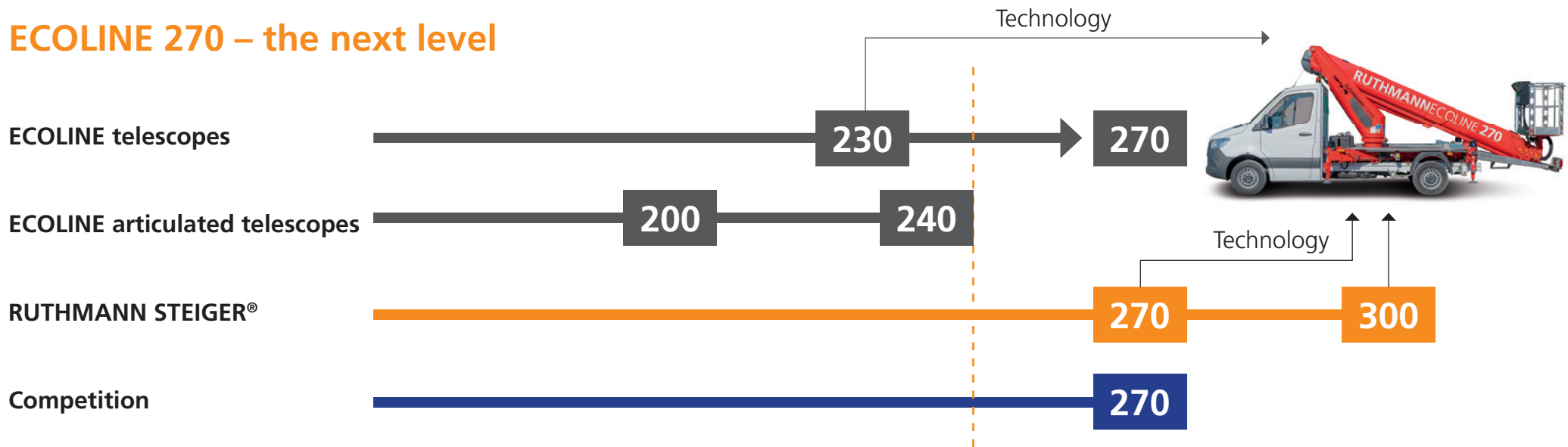





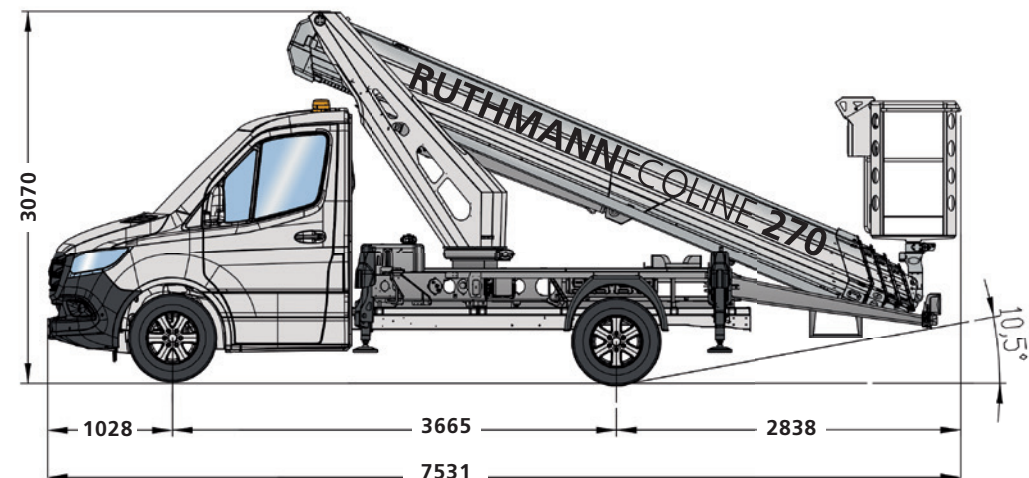

+ Short overall length 7.53 m --> significantly shorter as the competition, increased manoeuvrability, lower damage risk

+ To be mounted on the newest 3.5 t EURO 6 chassis



The perfect match!

-  Mature and optimised components from existing TB STEIGER® and ECOLINE machines
-  Proven ECOLINE control system with simple and intuitive operation based on the STEIGER® model (COCKPIT).
-  Long-term tested and 1,000-times proven stable boom system from the STEIGER® TB 270+
-  High quality stable turret construction following the current TB STEIGER® range
-  Optimised base frame from the ECOLINE 230 with light carrier from the current STEIGER® TB 270 pro
-  Compatible spare and wear parts ensure fast spare-part availability

The perfect match!





The new ECOLINE 270 associates the best of the ECOLINE and STEIGER® technology in one performant machine at an attractive price.



The perfect match!



FLEXIBLE STABILISATION VARIANTS

-  Variable stabilisation, even in narrow spaces
-  Modern HV stabilisation (horizontal/vertical) based on TB model
-  Narrow stabilisation possible in vehicle's profile
-  Enlarged stabilisation stroke for problem-free inclined positioning in combination with the wedge-shaped RUTHMANN supporting plates



Diversity of use for everyone

The new ECOLINE is attractive for a wide range of target groups. Maximum performance on a compact chassis make it universally applicable.

- Painters
- Building cleaners
- Arborists
- Roofers
- Network operators
- Municipalities
- Fire protection engineers
- Electricians
- and much more



ECOLINE 270



RUTHMANN Holdings GmbH
Ruthmannstraße 4
48712 Gescher
GERMANY

Phone: +49 2863 204-0
Fax: +49 2863 204-212

Internet: www.ruthmann.de
E-Mail: info@ruthmann.de

